

# Specification

**M170EG01VD**

**Version August 2007**

## Contents

<b>1. Handling Precautions .....</b>	<b>4</b>
<b>2. General Description.....</b>	<b>5</b>
2.1 Display Characteristics.....	5
<b>3. Functional Block Diagram.....</b>	<b>10</b>
<b>4. Absolute Maximum Ratings .....</b>	<b>11</b>
4.1 TFT LCD Module .....	11
4.2 Backlight Unit.....	11
4.3 Absolute Ratings of Environment.....	11
<b>5. Electrical characteristics.....</b>	<b>12</b>
5.1 TFT LCD Module .....	12
5.2 Backlight Unit.....	14
<b>6. Signal Characteristic .....</b>	<b>15</b>
6.1 Pixel Format Image.....	15
6.2 The Input Data Format.....	15
6.4 Timing Characteristics.....	18
6.5 Power ON/OFF Sequence.....	20
<b>7. Connector &amp; Pin Assignment .....</b>	<b>21</b>
7.1 TFT LCD Module .....	21
7.2 Backlight Unit.....	22
<b>8. Reliability Test .....</b>	<b>23</b>
<b>9. Shipping Label .....</b>	<b>24</b>
<b>10. Mechanical Characteristics.....</b>	<b>25</b>



## 1. Handling Precautions

- 1) Since front polarizer is easily damaged, pay attention not to scratch it.
- 2) Be sure to turn off power supply when inserting or disconnecting from input connector.
- 3) Wipe off water drop immediately. Long contact with water may cause discoloration or spots.
- 4) When the panel surface is soiled, wipe it with absorbent cotton or other soft cloth.
- 5) Since the panel is made of glass, it may break or crack if dropped or bumped on hard surface.
- 6) Since CMOS LSI is used in this module, take care of static electricity and insure human earth when handling.
- 7) Do not open or modify the Module Assembly.
- 8) Do not press the reflector sheet at the back of the module to any directions.
- 9) In case if a Module has to be put back into the packing container slot after once it was taken out from the container, do not press the center of the CCFL reflector edge. Instead, press at the far ends of the CCFL Reflector edge softly. Otherwise the TFT Module may be damaged.
- 10) At the insertion or removal of the Signal Interface Connector, be sure not to rotate nor tilt the Interface Connector of the TFT Module.
- 11) After installation of the TFT Module into an enclosure, do not twist nor bend the TFT Module even momentary. At designing the enclosure, it should be taken into consideration that no bending/twisting forces are applied to the TFT Module from outside. Otherwise the TFT Module may be damaged.
- 12) Cold cathode fluorescent lamp in LCD contains a small amount of mercury. Please follow local ordinances or regulations for disposal.
- 13) Small amount of materials having no flammability grade is used in the LCD module. The LCD module should be supplied by power complied with requirements of Limited Power Source (IEC60950 or UL1950), or be applied exemption.
- 14) The LCD module is designed so that the CCFL in it is supplied by Limited Current Circuit (IEC60950 or UL1950). Do not connect the CCFL in Hazardous Voltage Circuit.

## 2. General Description

This specification applies to the 17 inch Color TFT-LCD Module M170EG01 VD.

The display supports the SXGA+ (1280(H) x 1024(V)) screen format and 16.7M colors (RGB 6-bits+Hi-RFC data). All input signals are 2 Channel LVDS interface compatible.

This module does not contain an inverter card for backlight.

### 2.1 Display Characteristics

The following items are characteristics summary on the table under 25 °C condition:

Items	Unit	Specifications
Screen Diagonal	[mm]	432 (17.0")
Active Area	[mm]	337.920(H) × 270.336(V)
Pixels H x V		1280 × 3(RGB) × 1024
Pixel Pitch	[mm]	0.264(per one triad) × 0.264
Pixel Arrangement		R.G.B. Vertical Stripe
Display Mode		Normally White
White Luminance	[cd/m <sup>2</sup> ]	300 (center, Typ) @7.5 mA
Contrast Ratio		1000 : 1 (Typ)
Optical ResponseTime	[msec]	5 (Typ)
Nominal Input Voltage VDD	[Volt]	+5.0 (Typ)
Power Consumption	[Watt]	25.8 W (Typ) (PDD=6W, PCFL=19.8W @Lamp=7.5mA)
Weight	[Grams]	1990 Typ.
Physical Size (H x V x D)	[mm]	358.5(H) x 296.5(V) Typ. x 15.8(D) Max.
Electrical Interface		Dual Channel LVDS
Surface Treatment		Anti-glare type, Hardness 3H
Support Color		16.7M colors (RGB 6-bits + FRC data)
Temperature Range		
Operating	[°C]	0 to +50
Storage (Non-Operating)	[°C]	-20 to +60
RoHS Compliance		RoHS Compliance

## 2.2 Optical Characteristics

The optical characteristics are measured under stable conditions at 25°C (Room Temperature):

Item	Unit	Conditions	Min.	Typ.	Max.	Note
Viewing Angle	[degree]	Horizontal (Right) CR = 10 (Left)	70 70	80 80	-	1
		Vertical (Up) CR = 10 (Down)	70 70	80 80	-	
		Vertical (Right) CR = 5 (Left)	75 75	85 85	-	
		Vertical (Up) CR = 5 (Down)	75 75	85 85	-	
Luminance Uniformity	[%]	9 Points	75	80	-	2, 3
Optical Response Time	[msec]	Rising	-	3.5	6	4, 6
		Falling	-	1.5	3	
		Rising + Falling	-	5	9	
Color / Chromaticity Coordinates (CIE 1931)		Red x	0.618	0.648	0.678	4
		Red y	0.309	0.339	0.369	
		Green x	0.262	0.292	0.322	
		Green y	0.573	0.603	0.633	
		Blue x	0.113	0.143	0.173	
		Blue y	0.040	0.070	0.100	
		White x	0.283	0.313	0.343	
White y	0.299	0.329	0.359			
White Luminance (At CCFL= 7.5mA)	[cd/m <sup>2</sup> ]		240	300	-	4
Contrast Ratio			600	1000	-	4
Cross Talk (At 75Hz)	[%]		-	-	1.5	5
Flicker	[dB]		-	-	-20	7

Optical Equipment: BM-5A, BM-7, PR880, or equivalent

**Note 1: Definition of viewing angle**

Viewing angle is the measurement of contrast ratio  $\geq 10$ , at the screen center, over a 180° horizontal and 180° vertical range (off-normal viewing angles). The 180° viewing angle range is broken down as follows; 90° ( $\theta$ ) horizontal left and right and 90° ( $\Phi$ ) vertical, high (up) and low (down). The measurement direction is typically perpendicular to the display surface with the screen rotated about its center to develop the desired measurement viewing angle.

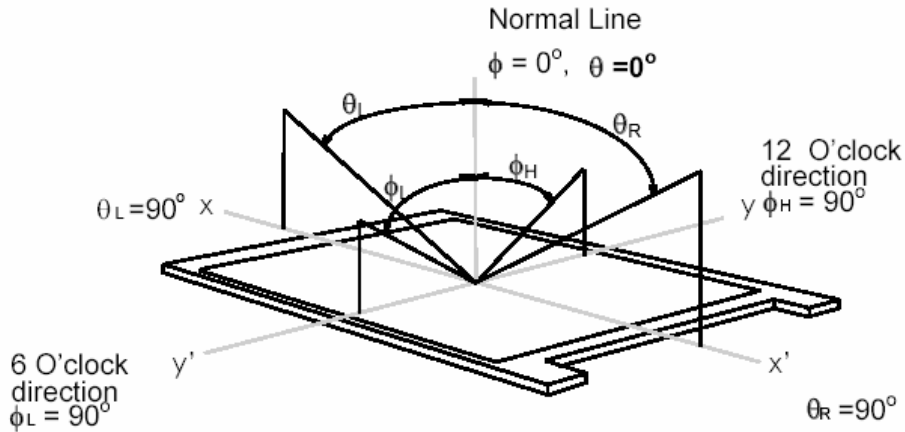

**Note 2: 9 points position**

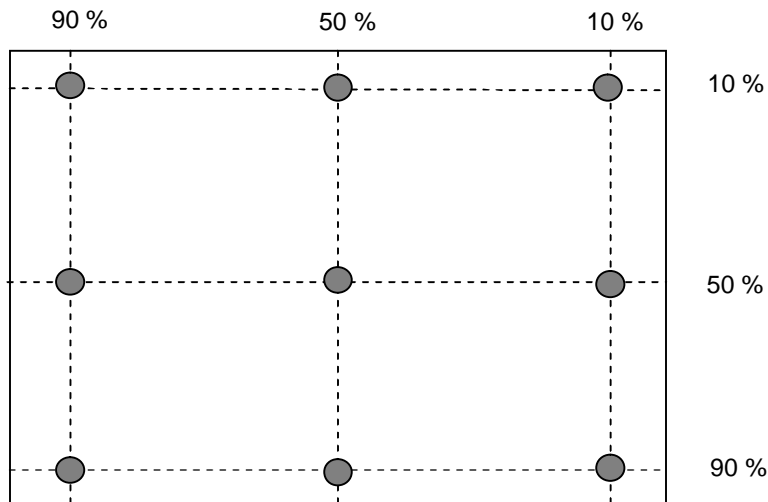

Note 3: The luminance uniformity of 9 points is defined by dividing the maximum luminance values by the minimum test point luminance

$$\delta_{w9} = \frac{\text{Maximum Luminance of 9 points}}{\text{Minimum Luminance of 9 points}}$$

### Note 4: Measurement method

The LCD module should be stabilized at given temperature for 30 minutes to avoid abrupt temperature change during measuring. In order to stabilize the luminance, the measurement should be executed after lighting Backlight for 30 minutes in a stable, windless and dark room.

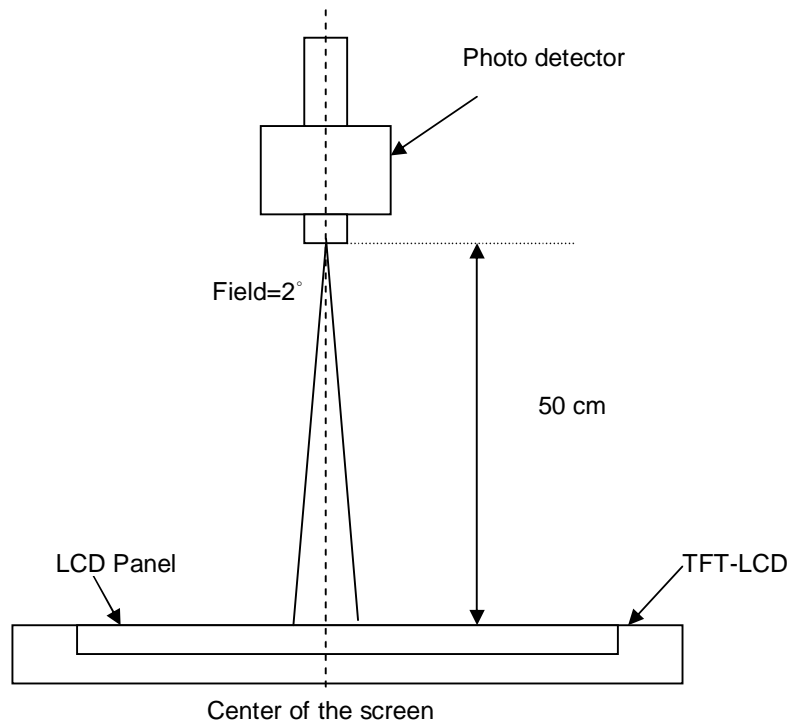

### Note 5: Definition of Cross Talk (CT)

$$CT = | Y_B - Y_A | / Y_A \times 100 (\%)$$

Where

$Y_A$  = Luminance of measured location without gray level 0 pattern (cd/m<sup>2</sup>)

$Y_B$  = Luminance of measured location with gray level 0 pattern (cd/m<sup>2</sup>)

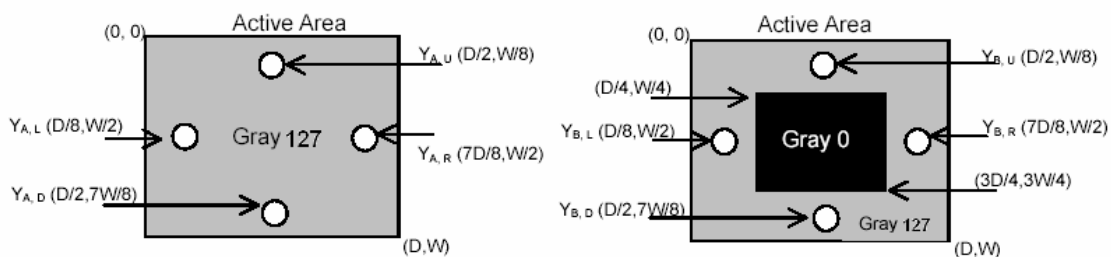

Note 6: Definition of response time:

The output signals of photo detector are measured when the input signals are changed from “Full Black” to “Full White” (rising time), and from “Full White” to “Full Black ”(falling time), respectively. The response time is interval between the 10% and 90% of amplitudes. Please refer to the figure as below.

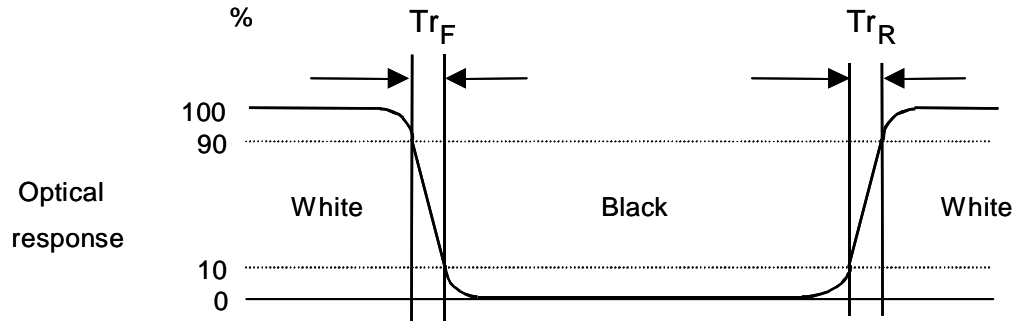

Note 7: Subchecker Pattern

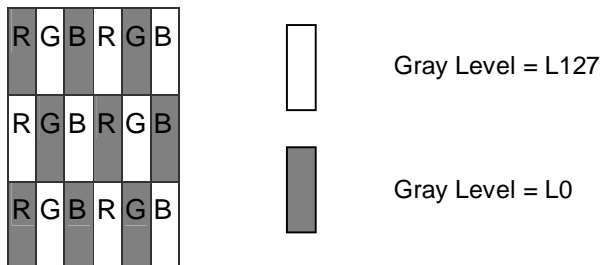

Method: Record dBV & DC value with (WESTAR)TRD-100

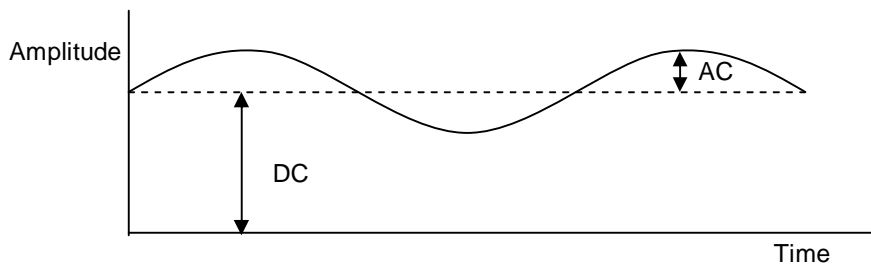

$$\text{Flicker (dB)} = 20 \log \frac{\text{AC Level(at 30 Hz)}}{\text{DC Level}}$$

### 3. Functional Block Diagram

The following diagram shows the functional block of the 17.0 inches Color TFT-LCD Module:

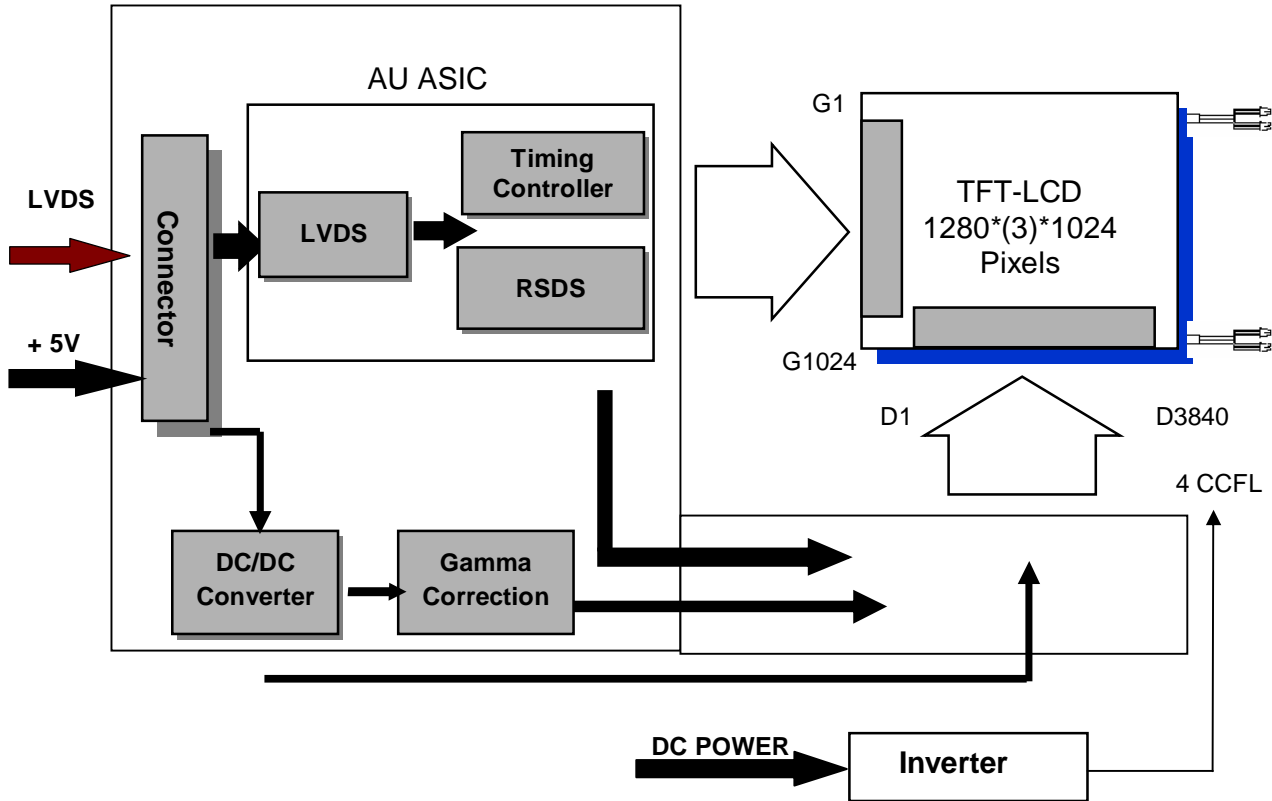

I/F + X-PCB

JAE FI-XB30SSL-HF15

YEONHO 35001HS-02L

## 4. Absolute Maximum Ratings

Absolute maximum ratings of the module is as following:

### 4.1 TFT LCD Module

Item	Symbol	Min	Max	Unit	Conditions
Logic/LCD Drive	VIN	-0.3	6	[Volt]	<b>Note 1,2</b>

### 4.2 Backlight Unit

Item	Symbol	Min	Max	Unit	Conditions
CCFL Current	ICFL	-	8	[mA] rms	<b>Note 1,2</b>

### 4.3 Absolute Ratings of Environment

Item	Symbol	Min	Max	Unit	Conditions
Operating Humidity	HOP	5	90	[%RH]	<b>Note 3</b>
Storage Temperature	TST	-20	+60	[°C]	
Storage Humidity	HST	5	90	[%RH]	

**Note 1:** With in Ta (25°C )

**Note 2:** Permanent damage to the device may occur if exceed maximum values

**Note 3:** For quality performance, please refer to AUO IIS (Incoming Inspection Standard).

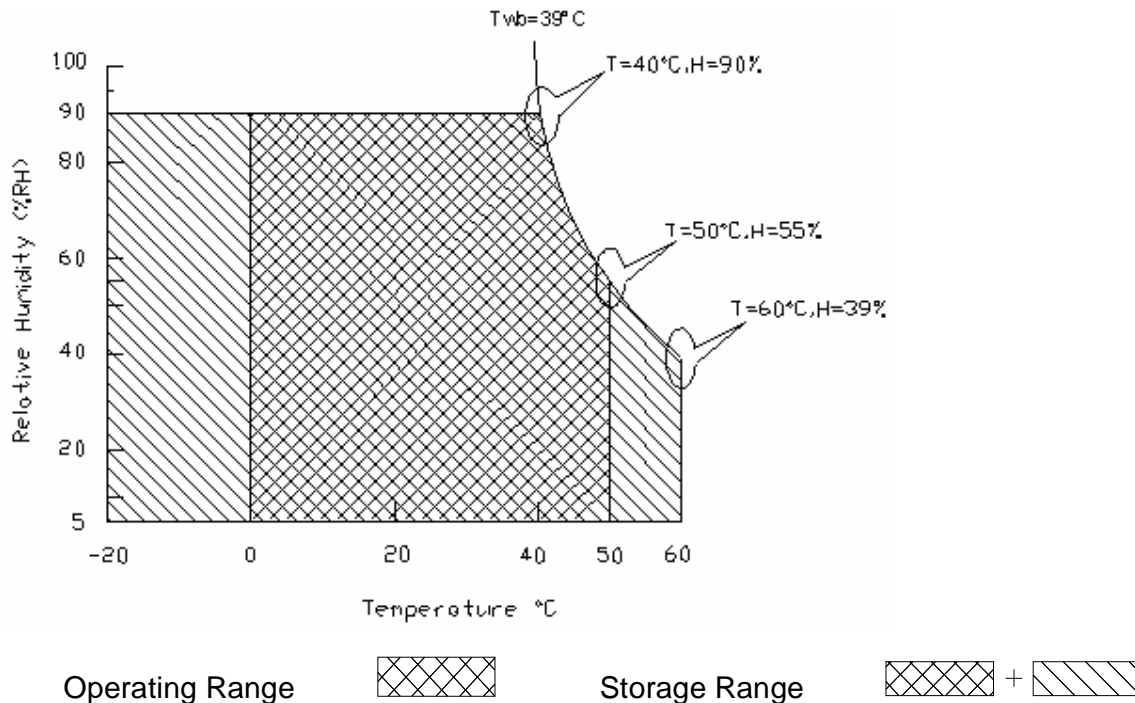

## 5. Electrical characteristics

### 5.1 TFT LCD Module

#### 5.1.1 Power Specification

Input power specifications are as follows:

Symble	Parameter	Min.	Typ.	Max.	Unit	Condition
VCC	Logic/LCD Drive Voltage	4.5	5.0	5.5	[Volt]	± 10%
ICC	Input Current	-	1.2	1.56	[A]	Vin=5V , All Black Pattern, at 75Hz
IRush	Inrush Current	-	-	3.0	[A]	Note
PCC	VCCPower	-	6	7.8	[Watt]	Vin=5V , All Black Pattern, at 75Hz

Note: Measurement conditions:

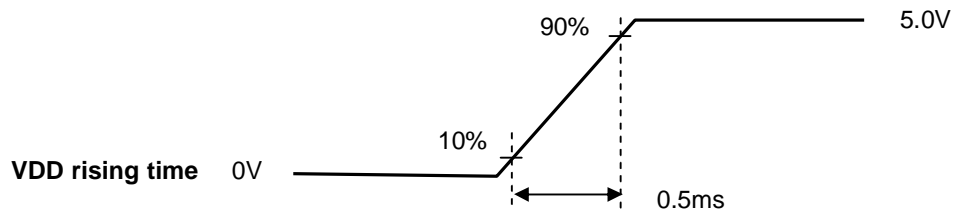
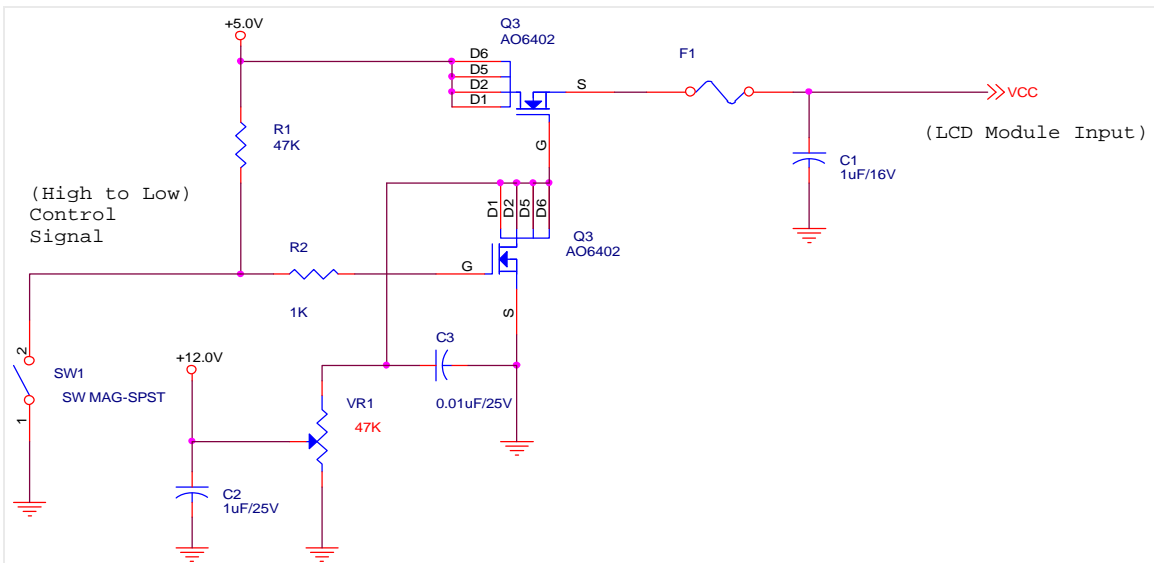

## 5.1.2 Signal Electrical Characteristics

Input signals shall be low or Hi-Z state when Vin is off

It is recommended to refer the specifications of SN75LVDS82DGG (Texas Instruments) in detail.

Each signal characteristics are as follows;

Symbol	Parameter	Min	Typ	Max	Units	Condition
VTH	Differential Input High Threshold	-	-	+100	[mV]	VICM = 1.2V <b>Note</b>
VTL	Differential Input Low Threshold	-100	-	-	[mV]	VICM = 1.2V <b>Note</b>
VID	Input Differential Voltage	100	400	600	[mV]	<b>Note</b>
VICM	Differential Input Common Mode Voltage	+1.0	+1.2	+1.5	[V]	VTH/VTL = ±100mV <b>Note</b>

**Note:** LVDS Signal Waveform

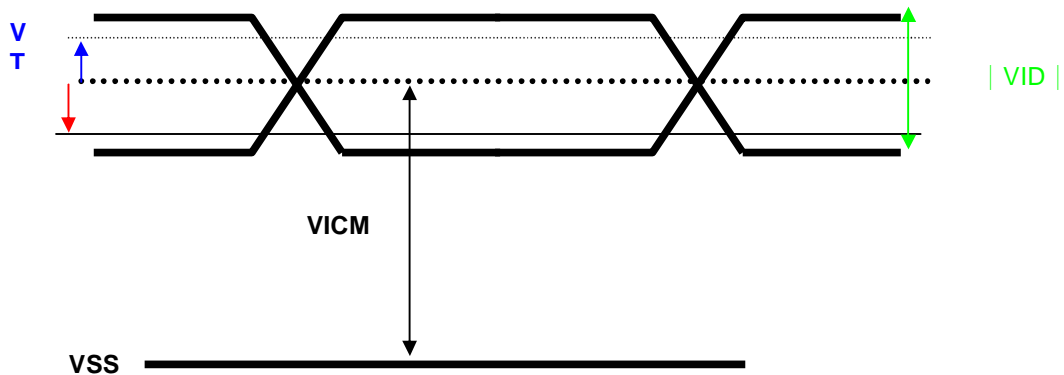

## 5.2 Backlight Unit

Parameter guideline for CCFL Inverter

Symbol	Parameter	Min.	Typ.	Max.	Unit	Condition
ISCFL	CCFL standard current	7.0	7.5	8.0	[mA] rms	(Ta=25°C) <b>Note 2</b>
IRCFL	CCFL operation range	3.0	7.5	8.0	[mA] rms	(Ta=25°C) <b>Note 2</b>
FCFL	CCFL Frequency	40	60	80	[KHz]	(Ta=25°C) <b>Note 3,4</b>
ViCFL (0°C)	CCFL Ignition Voltage (End of the lamp wire connector)	1500	-		[Volt] rms	(Ta=0°C) <b>Note 5</b>
ViCF (25°C)	CCFL Ignition Voltage (End of the lamp wire connector)	1150	-		[Volt] rms	(Ta=25°C) <b>Note 5</b>
VCFL	CCFL Operation Voltage	TBD	660 @ 7.5mA	700 @ 7.5mA	[Volt] rms	(Ta=25°C) <b>Note 6</b>
PCFL	CCFL Power consumption (for reference)	-	19.8	21.8	[Watt]	(Ta=25°C) <b>Note 6</b>
LTCFL	CCFL life Time	40,000	50,000	-	[Hour]	(Ta=25°C)

Note 1: Typ. are AUO recommended design points.

- \*1 All of characteristics listed are measured under the condition using the AUO test inverter.
- \*2 In case of using an inverter other than listed, it is recommended to check the inverter carefully. Sometimes, interfering noise stripes appear on the screen, and substandard luminance or flicker at low power may happen.
- \*3 In designing an inverter, it is suggested to check safety circuit very carefully. Impedance of CCFL, for instance, becomes more than 1 [M ohm] when CCFL is damaged.
- \*4 Generally, CCFL has some amount of delay time after applying kick-off voltage. It is recommended to keep on applying kick-off voltage for 1 [Sec] until discharge.
- \*5 Reducing CCFL current increases CCFL discharge voltage and generally increases CCFL discharge frequency. So all the parameters of an inverter should be carefully designed so as not to produce too much leakage current from high-voltage output of the inverter.

Note 2: It should be employed the inverter which has "Duty Dimming", if IRCFL is less than 3mA.

Note 3: CCFL discharge frequency should be carefully determined to avoid interference between inverter and TFT LCD.

Note 4: The frequency range will not affect to lamp life and reliability characteristics.

Note 5: CCFL inverter should be able to give out a power that has a generating capacity of over 1,500 voltage. Lamp units need 1,500 voltage minimum for ignition.

Note 6: The variance of CCFL power consumption is  $\pm 10\%$ . Calculator value for reference (ISCFL  $\times$  VCFL  $\times$  4= PCFL)

Note 7: Definition of Life time: Brightness becomes 50%. The typical life time CCFL in on the condition at 7.5 m A lamp current.

## 6. Signal Characteristic

### 6.1 Pixel Format Image

Following figure shows the relationship of the input signals and LCD pixel format.

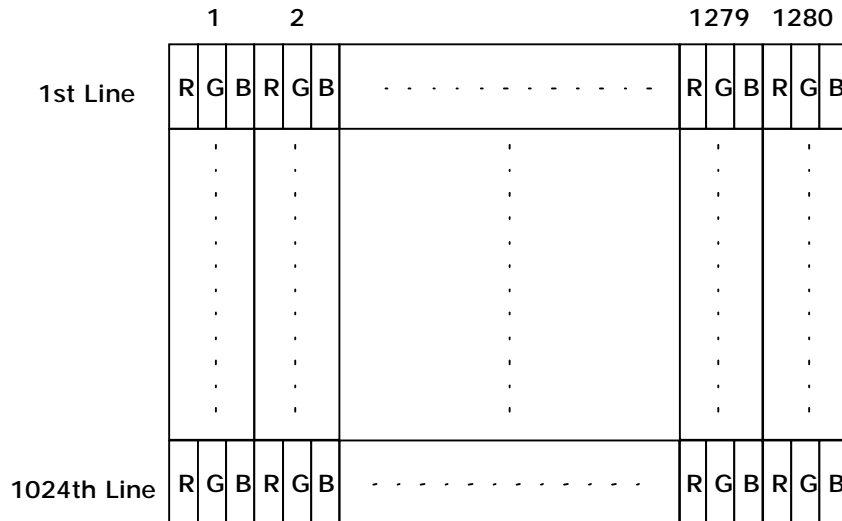

### 6.2 The Input Data Format

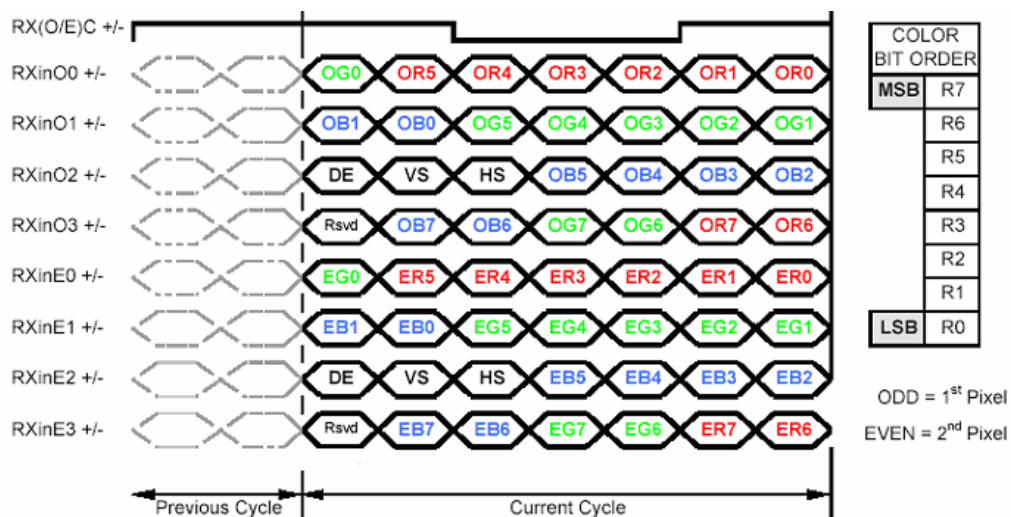

Note1: Normally, DE, VS, HS on EVEN channel are not used.

Note2: Please follow PSWG.

Note3: 8-bit in

## 6.3 Signal Description

The module using a pair of LVDS receiver SN75LVDS82(Texas Instruments) or compatible. LVDS is a differential signal technology for LCD interface and high speed data transfer device. Transmitter shall be SN75LVDS83(negative edge sampling) or compatible. The first LVDS port(RxOxxx) transmits odd pixels while the second LVDS port(RxExxx) transmits even pixels.

PIN #	SIGNAL NAME	DESCRIPTION
1	RxO0-	Negative LVDS differential data input (Odd data)
2	RxO0+	Positive LVDS differential data input (Odd data)
3	RxO1-	Negative LVDS differential data input (Odd data)
4	RxO1+	Positive LVDS differential data input (Odd data)
5	RxO2-	Negative LVDS differential data input (Odd data, H-Sync,V-Sync,DSPTMG)
6	RxO2+	Positive LVDS differential data input (Odd data, H-Sync,V-Sync,DSPTMG)
7	GND	Power Ground
8	RxOC-	Negative LVDS differential clock input (Odd clock)
9	RxOC+	Positive LVDS differential clock input (Odd clock)
10	RxO3-	Negative LVDS differential data input (Odd data)
11	RxO3+	Positive LVDS differential data input (Odd data)
12	RxE0-	Negative LVDS differential data input (Even clock)
13	RxE0+	Positive LVDS differential data input (Even data)
14	GND	Power Ground
15	RxE1-	Positive LVDS differential data input (Even data)
16	RxE1+	Negative LVDS differential data input (Even data)
17	GND	Power Ground
18	RxE2-	Negative LVDS differential data input (Even data)
19	RxE2+	Positive LVDS differential data input (Even data)
20	RxEC-	Negative LVDS differential clock input (Even clock)
21	RxEC+	Positive LVDS differential clock input (Even clock)
22	RxE3-	Negative LVDS differential data input (Even data)
23	RxE3+	Positive LVDS differential data input (Even data)
24	GND	Power Ground
25	GND	Power Ground
26	NC	No contact (For AUO test only)
27	GND	Power Ground
28	VCC	+5.0V Power Supply
29	VCC	+5.0V Power Supply
30	VCC	+5.0V Power Supply

Note1: Start from left side

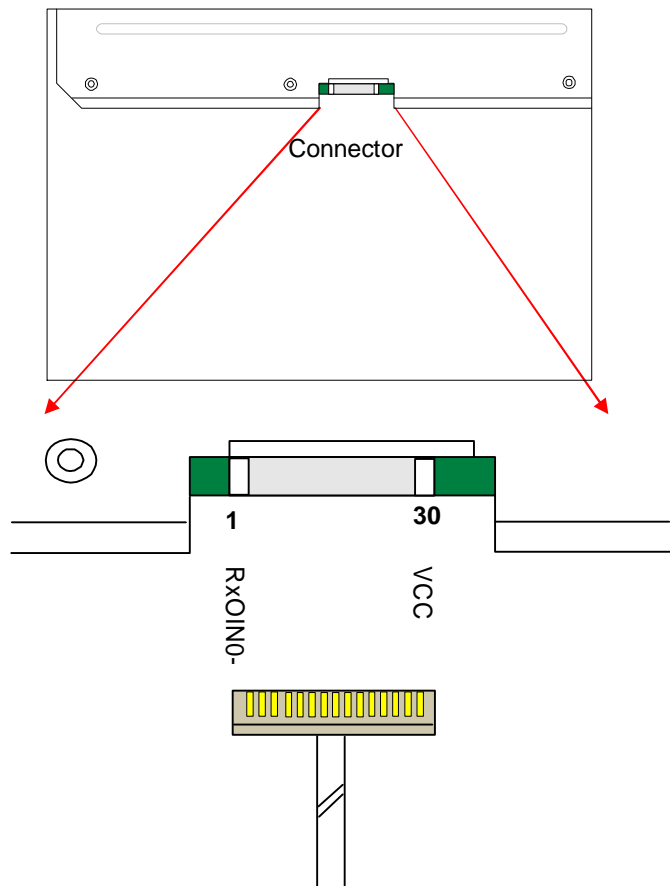

Note2: Input signals of odd and even clock shall be the same timing.

Note3: Please follow PSWG.

## 6.4 Timing Characteristics

### 6.4.1 Timing Characteristics

Basically, interface timings described here is not actual input timing of LCD module but output timing of SN75LVDS82DGG (Texas Instruments) or equivalent.

Signal	Item	Symbol	Min	Typ	Max	Unit
Vertical Section	Period	Tv	1032	1066	2048	Th
	Active	Tdisp(v)	1024	1024	1024	Th
	Blanking	Tbp(v)+Tfp(v)+PWvs	8	42	1024	Th
Horizontal Section	Period	Th	680	844	2048	Tclk
	Active	Tdisp(h)	640	640	640	Tclk
	Blanking	Tbp(h)+Tfp(h)+PWhs	40	204	1408	Tclk
Clock	Period	Tclk	14.81	18.52	-	ns
	Frequency	Freq	40	54	70	MHz
Frame rate	Frame rate	F	49	60	76	Hz

**Note :** DE mode only

## 6.4.2 Timing Diagram

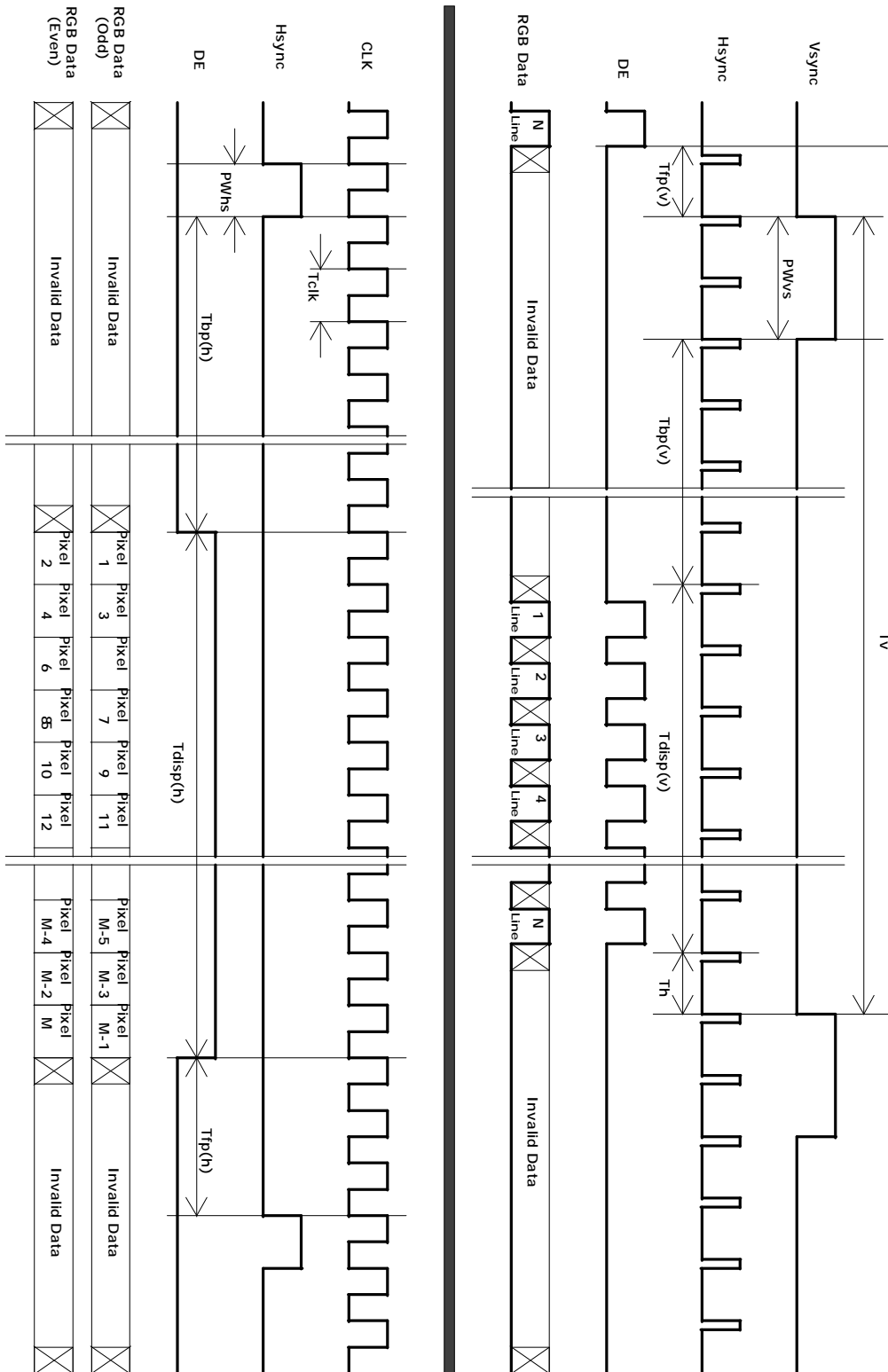

## 6.5 Power ON/OFF Sequence

VDD power and lamp on/off sequence is as follows. Interface signals are also shown in the chart. Signals from any system shall be Hi-Z state or low level when VDD is off.

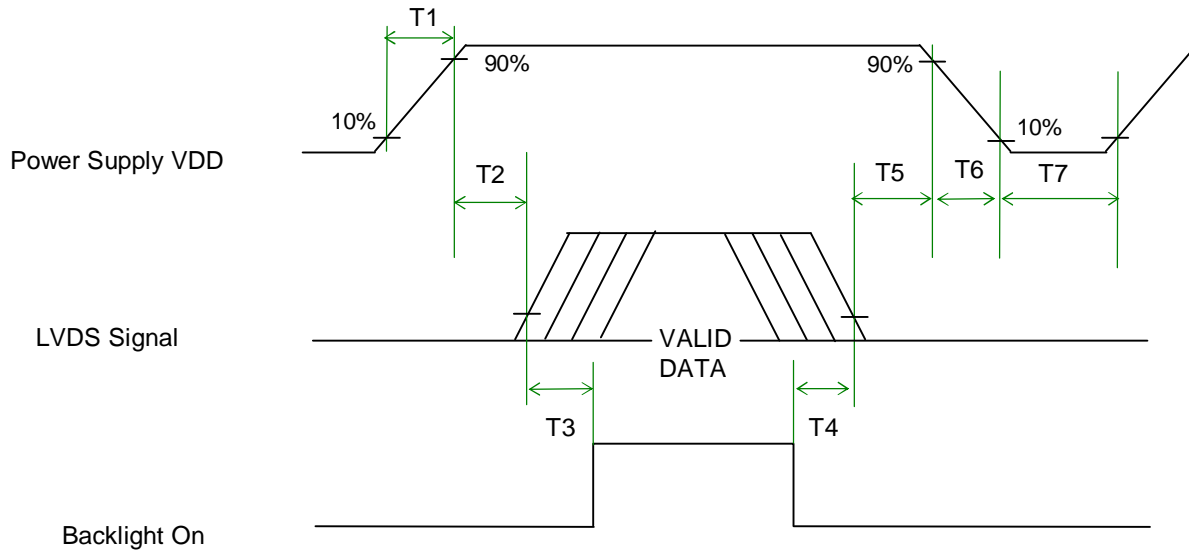

**Power Sequence Timing**

Parameter	Value			Unit
	Min.	Typ.	Max.	
T1	0.5	-	10	[ms]
T2	0	-	10	[ms]
T3	300	-	-	[ms]
T4	100	-	-	[ms]
T5	0	16	50	[ms]
T6	-	-	10	[ms]
T7	1000	-	-	[ms]

Note: The values of the table are follow PSWG.

## 7. Connector & Pin Assignment

Physical interface is described as for the connector on module. These connectors are capable of accommodating the following signals and will be following components.

### 7.1 TFT LCD Module

#### 7.1.1 Connector

Connector Name / Designation	Interface Connector / Interface card
Manufacturer	JAE / Hirose or compatible
Type Part Number	FI-XB30SSL-HF15 / MDF76TW-30S-1H(58)
Mating Housing Part Number	JAE FI-X30HL

#### 7.1.2 Pin Assignment

Pin#	Signal Name	Pin#	Signal Name
1	RxOIN0-	2	RxOIN0+
3	RxOIN1-	4	RxOIN1+
5	RxOIN2-	6	RxOIN2+
7	GND	8	RxOCLKIN-
9	RxOCLKIN+	10	RxOIN3-
11	RxOIN3+	12	RxEIN0-
13	RxEIN0+	14	GND
15	RxEIN1-	16	RxEIN1+
17	GND	18	RxEIN2-
19	RxEIN2+	20	RxECLKIN-
21	RxECLKIN+	22	RxEIN3-
23	RxEIN3+	24	GND
25	NC	26	NC
27	NC	28	VCC
29	VCC	30	VCC

## 7.2 Backlight Unit

Physical interface is described as for the connector on module. These connectors are capable of accommodating the following signals and will be following components.

Connector Name / Designation	Lamp Connector / Backlight lamp
Manufacturer	YEONHO
Type Part Number	35001HS-02L
Mating Type Part Number	35001WR-00LS00

### 7.2.1 Signal for Lamp connector

	Connector No.	Pin No.	Input	Color	Function
Upper	CN1	1	Hot1	Pink	High Voltage (Lamp 1)
		2	Cold1	White	Low Voltage (Lamp 1)
	CN2	1	Hot2	Blue	High Voltage (Lamp 2)
		2	Cold2	Black	Low Voltage (Lamp 2)

	Connector No.	Pin No.	Input	Color	Function
Lower	CN3	1	Hot1	Pink	High Voltage (Lamp 3)
		2	Cold1	White	Low Voltage (Lamp 3)
	CN4	1	Hot2	Blue	High Voltage (Lamp 4)
		2	Cold2	Black	Low Voltage (Lamp 4)

## 8. Reliability Test

Environment test conditions are listed as following table.

Items	Required Condition	Note
Temperature Humidity Bias (THB)	Ta= 50°C, 80%RH, 300hours	
High Temperature Operation (HTO)	Ta= 50°C, 50%RH, 300hours	
Low Temperature Operation (LTO)	Ta= 0°C, 300hours	
High Temperature Storage (HTS)	Ta= 60°C, 300hours	
Low Temperature Storage (LTS)	Ta= -20°C, 300hours	
Vibration Test (Non-operation)	Acceleration: 1.5 G Wave: Random Frequency: 10 - 200 - 10 Hz Sweep: 30 Minutes each Axis (X, Y, Z)	
Shock Test (Non-operation)	Acceleration: 50 G Wave: Half-sine Active Time: 20 ms Direction: ±X, ±Y, ±Z (one time for each Axis)	
Drop Test	Height: 60 cm, package test	
Thermal Shock Test (TST)	-20°C/30min, 60°C/30min, 100 cycles	1
On/Off Test	On/10sec, Off/10sec, 30,000 cycles	
ESD (ElectroStatic Discharge)	Contact Discharge: ± 8KV, 150pF(330Ω ) 1sec, 8 points, 25 times/ point.	2
	Air Discharge: ± 15KV, 150pF(330Ω ) 1sec 8 points, 25 times/ point.	
Altitude Test	Operation:10,000 ft Non-Operation:30,000 ft	

Note 1: The TFT-LCD module will not sustain damage after being subjected to 100 cycles of rapid temperature change. A cycle of rapid temperature change consists of varying the temperature from -20°C to 60°C, and back again. Power is not applied during the test. After temperature cycling, the unit is placed in normal room ambient for at least 4 hours before power on.

Note 2: According to EN61000-4-2, ESD class B: Some performance degradation allowed. No data lost. Self-recoverable. No hardware failures.

**9. Shipping Label**

The shipping label format is shown as below.

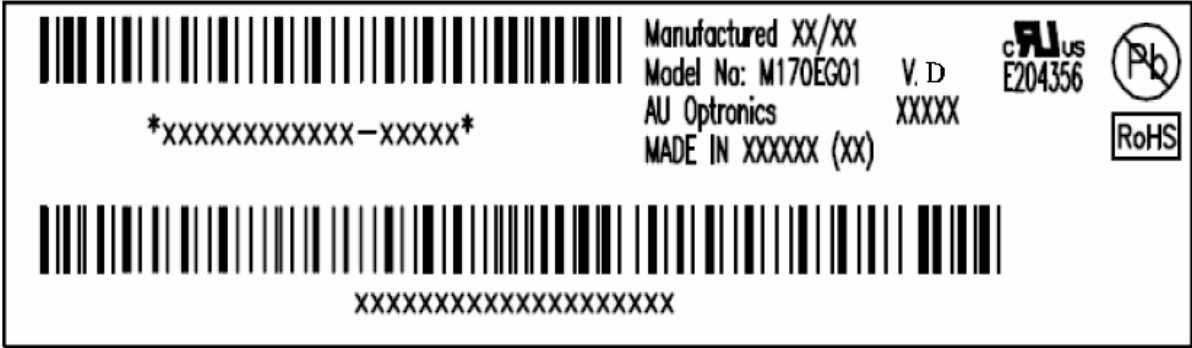





Data Modul Headquarters Munich  
Landsberger-Str. 322  
D-80687 Munich - Germany  
Tel.: +49-89-56017-0



Sales Office Berlin  
berlin@data-modul.com  
Germany  
Tel.: +49-033397/67909



Sales Office Duesseldorf  
Fritz-Vomfelde-Str. 8  
40547 Duesseldorf - Germany  
Tel.: +49-211-52709-0



Sales Office Stuttgart  
Friedrich-List-Str. 42  
70771 Leinfelden-Echterdingen  
Germany  
Tel.: +49-711-782385-0

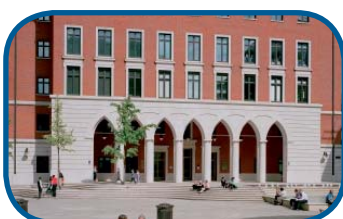

Data Modul France, S.A.R.L.  
Bat B - Hall 204  
1-3 Rue des Campanules  
77185 Lognes - France  
Tel.: +33-1-60378100



Data Modul Italia, S.r.l.  
Regus Center Senigallia  
Via Senigallia 18/2  
20161 Milano - Italy  
Tel.: +39-02-64672-509



Data Modul Iberia, S.L.  
c/ Adolfo Pérez Esquivel 3  
Edificio Las Americas III Oficiana 40  
28230 Parque Empresarial  
Madrid Las Rozas - Spain  
Tel.: +34-609 61 80 40

Data Modul Ltd. / UK  
3 Brindley Place  
Birmingham B 12JB  
United Kingdom  
Tel.: +44-121-698-8641

Data Modul Inc. / USA  
1767-46 Veterans Memorial Highway  
Islandia NY 11749  
USA  
Tel.: +1-877-951-0800